



**P A C K A G I N G**  
AND MORE

LESER GmbH  
P.O. 2168 · D-77911 Lahr  
Phone: +49 7821 58 03 - 0  
Fax: +49 7821 58 03 - 70

[www.leser.de](http://www.leser.de)  
[leser@leser.de](mailto:leser@leser.de)



„Made in Germany“ ist für LESER nicht nur ein Slogan, sondern eine Werteeinstellung, die wir seit mehr als acht Jahrzehnten leben. Viele unserer Produkte tragen dieses Gütesiegel. Darüber hinaus ist unser Haus seit über 20 Jahren nach DIN EN ISO 9001 (Qualitätsmanagementsystem) sowie DIN EN ISO 14001 (Umweltmanagementsystem) zertifiziert.

Als weltweit erstes Unternehmen in unserer Branche haben wir mit der Serie 1560 „EARTH“ eine Verpackung aus Biokunststoff auf den Markt gebracht und somit unseren eigenen Anspruch nach Ressourcenschonung und Umweltschutz nochmals unterstrichen.

Dieses Konzept verfolgen wir konsequent weiter und so freut es uns, dass wir Ihnen in unserem neuen Katalog nun auch viele Produkte mit dem FSC®-Label präsentieren dürfen. Damit dokumentieren wir unser Anliegen, die Standards des Forest Stewardship Council® für eine verantwortungsvolle Waldwirtschaft einzuhalten und somit unsere Wälder für kommende Generationen zu erhalten. Achten Sie also beim Durchblättern des neuen Katalogs auf „Made in Germany“, besonders auf die gekennzeichneten FSC®-zertifizierten Kartonschachteln, und begleiten Sie uns auf dem Weg der Nachhaltigkeit.

„Made in Germany“ is for LESER not only a slogan but a values setting we have been living for more than 8 decades. Many of our products have this seal of approval.

Moreover our company is certified with DIN EN ISO 9001 (quality management system) as well as DIN EN ISO 14001 (environment management system) for more than 20 years.

As the first company in our business worldwide, we launched a packing made from bioplastic, our series 1560 „EARTH“, and so emphasize our claim for the protection of resources and environmental protection.

We follow this concept consequently and are glad to be able to present you now many products with the FSC®-Label in our new catalogue. With this we document our concern to follow the standards of the Forest Stewardship Council® for a responsible forestry.

Pay attention to the specially marked FSC®-certified cardboard boxes „Made in Germany“ when perusing the new catalogue and come with us on the way to sustainability.

Pour Leser le „Made in Germany“ n’est pas seulement un slogan mais représente plutôt une valeur que nous incarnons depuis plus de 80 ans.

Beaucoup de nos produits détiennent ce label. En outre notre maison est certifiée depuis plus de 20 ans ISO 9001 (système de management) et ISO 14001 (respect de l’environnement).

Nous avons été le premier au monde dans notre secteur d’activité à lancer sur le marché une gamme d’emballages en bio-plastique: 1560 „EARTH“ montrant ainsi notre engagement pour la préservation des ressources et de l’environnement.

Nous poursuivons dans cette voie et sommes fiers de présenter plusieurs produits avec le label FSC® dans notre nouveau catalogue, affirmant ainsi notre volonté de respecter les standards du Forest Stewardship Council® pour une gestion responsable des forêts.

Soyez attentifs en feuilletant ce catalogue au „Made in Germany“ et en particulier aux boîtes en carton certifiées FSC® et accompagnez-nous sur la voie du développement durable.

„Made in Germany“ es para LESER no solamente un eslogan, además es una actitud de valores, que vivimos desde hace más que ocho décadas. Muchos de nuestros productos llevan este sello de calidad.

Además nuestra firma está certificada desde más de 20 años según DIN EN ISO 9001 (sistema de gestión de calidad) así como DIN EN ISO 14001 (sistema de gestión ambiental).

Como primera empresa del sector a nivel mundial lanzamos con nuestra serie 1560 „EARTH“ un embalaje de bioplástico, subrayando así nuestra exigencia para la protección de recursos y del medioambiente.

Seguimos este concepto consecuentemente y nos alegramos de poder presentar muchos productos con el sello FSC®. Así documentamos nuestro deseo de respetar los estándares del Forest Stewardship Council® para una silvicultura responsable y la conservación de la naturaleza para las generaciones venideras.

Por esto fíjense en el „Made in Germany“ y especialmente en las cajas de cartón marcadas con el sello FSC® al oír el nuevo catálogo – y acompañenos en el camino de la sostenibilidad.

Jochen Leser

Ralf Leser



# INHALT CONTENTS SOMMAIRE ÍNDICE



**6-7** MADE IN GERMANY  
SERIE 0120 ELEMENT



**8-9** MADE IN GERMANY  
SERIE 0134 JUBILEE



**10-11** MADE IN GERMANY  
SERIE 0135 PICOT



**12-13** MADE IN GERMANY  
SERIE 0140 FLOWER



**14-15** MADE IN GERMANY  
SERIE 0145 SWITCH



**16-17** **NEW** MADE IN GERMANY  
SERIE 0150 RECYCLE

**18-19**  
SERIE 0230 PLAIN

**20-21**  
SERIE 0255 JOY

**22**  
SERIE 0275 CELEBRATION

**23**  
SERIE 0276 LOOP

**56-57**  
Uhrenetuis  
Watch boxes  
Ecrins montre  
Estuches reloj

**58-59** **NEW**  
Antragsringe / Trauringe  
Engagement Ring / Wedding Ring  
Bague de Fiançailles / Alianzas  
Anillo de Compromiso / Alianzas



**60-61**  
Tragetaschen / Accessoires  
Paper Bag / Accessories  
Sacs Papier / Accessoires  
Bolsas Papel / Accesorios

**24-25**  
SERIE 0280 CROCO

**26-27**  
SERIE 0735 LINE

**28-29**  
SERIE 0830 CASE

**30-31** MADE IN GERMANY  
SERIE 1560 EARTH

**32-33** **NEW** MADE IN GERMANY  
SERIE 1700 FUTURA

**34-35** MADE IN GERMANY  
SERIE 1750 FUTURA S

**36-37** MADE IN GERMANY  
SERIE 2250 SHINE

**38-39**  
SERIE 5100 ELEGANCE

**40-41**  
SERIE 5510 POESIE

**42-43** **NEW**  
SERIE 5520 STRAIGHT

**62-63**  
GIVE-AWAYS

**64-65**  
Fixboxen / Schmuckbeutel  
Fix Boxes / Jewellery Bags  
Boîtes cartonnées /  
Pochettes de bijoux  
Fix Box / Bolsitas para Joyería

**68-77**  
Dekoserien  
Deco Systems  
Déco Systèmes  
Sistemas de Decoración

**44-45**  
SERIE 5530 BRILLIANT

**46-47**  
SERIE 5850 SOFT TOUCH

**48-49**  
SERIE 5880 ALORS

**50-51**  
SERIE 5890 ATTICO

**52-53**  
SERIE 5950 FRAME

**54-55**  
SERIE 6410 BLACKWOOD

**67**  
SERIE 5960 ECO-FRAME

**66** **NEW**  
Spezial Video-Box  
Special Video-Box  
Boîte vidéo spéciale  
Caja de video especial

**78**  
Trauringständer  
Wedding ring stand  
Présentoir pour alliances  
Displays para alianzas

**79-81**  
Lager- und Vorlagetabletts  
Trays for storage & presentation  
Cuvettes de rangement  
et de présentation  
Bandejas de almacenaje  
y de presentación

**82-85** MADE IN GERMANY  
Möbel-Einbau-Systeme  
Furniture systems  
Meubles de rangement  
Sistemas de muebles



## SERIE 0150 RECYCLE

Kartonschachteln aus recycelten Materialien | Cardboard boxes made from recycled materials  
Écrins en cartons fabriqués à partir de matériaux recyclés | Cajas de cartón de materiales reciclados

Green PACK  
by LESER

MADE IN GERMANY



0150 88 UNI   
80 x 80 x 22 mm

0150 66 UNI   
60 x 60 x 22 mm

0150 26   
50 x 50 x 30 mm

0150 39   
158 x 158 x 25 mm

FARBEN COLOURS COULEURS COLORES

Seite 16/17  
Page 16/17  
Página 16/17

**NEW**   
001001

**NEW**   
005001

Farbe innen  
Colour inside  
Couleur intérieure  
Color interior

# Design YOUR box

Lassen Sie unsere Serien zu Ihrer Eigenen werden. | Let our series become your own.  
Laissez nos séries devenir la vôtre. | Deje que nuestra serie se convierta en su propia.

Und so funktioniert es | And that is how it works | Et voilà comment cela fonctionne |  
Y así funciona

1. Gewünschte Serie wählen | Select the desired series | Sélectionnez la série désirée  
Selecione la serie deseada



2. Das Dekor wählen | Choose the motive | Choisissez le motif | Elija el motivo

VALENTINE



FLOWER



BUTTERFLIES



IVY



SQUARE



REED



STRIPES



MODERN



BAUBLE



TREE



CLASSIC\*



\*  
*Merry Christmas*  
*Joyeux Noël*  
*Feliz Navidad*

TOY



BABY SUCKER



MOON



TEDDY



3. IHR Dekor - IHRE Box | YOUR motive - YOUR box | VOTRE motif - VOTRE boîte  
SU motivo - SU caja





# SERIE 0120 ELEMENT

Kartonschachteln mit Watte | Lift-off cardboard boxes with cotton inside  
Boîtes en carton avec intérieur ouate | Cajas de cartón con guata



0120 89 UNI  
85 x 85 x 60 mm

0120 66 UNI    
60 x 60 x 22 mm





0120 44 UNI   
40 x 40 x 18 mm



0120 88 UNI   
80 x 80 x 22 mm



0120 39    
158 x 158 x 25 mm



0120 46 UNI   
120 x 90 x 20 mm

## FARBEN COLOURS COULEURS COLORES





Seite 4  
Page 4  
Página 4

### SPECIAL

TRAGETASCHEN	60
BAGS	60
SACS	60
BOLSAS	60



002003

Farbe innen   
Colour inside   
Couleur intérieure  
Color interior



# SERIE 0134 JUBILEE

Kartonschachteln mit Schaumstoffeinlage und zusätzlicher Schaumstoffabdeckung | Lift-off cardboard boxes with foam pad inside and additional protection foam | Boîtes en carton avec intérieur mousse floquée avec découpes et mousse de protection supplémentaire  
Cajas de cartón con interior de espuma con cortes y espuma adicional para tapar





0134 26     
50 x 50 x 30 mm

0134 66 UNI    
60 x 60 x 22 mm



0134 88 UNI    
80 x 80 x 22 mm



0134 39    
158 x 158 x 25 mm

## FARBEN COLOURS COULEURS COLORES

### SPECIAL



TRAGETASCHEN	60
BAGS	60
SACS	60
BOLSAS	60



 Abdeckschaum  
Foam pad  
Mousse de protection  
Espuma para tapar



225001

 Farbe innen  
Colour inside  
Couleur intérieure  
Color interior 



# SERIE 0135 PICOT

Kartonschachteln mit Schaumstoffeinlage und zusätzlicher Schaumstoffabdeckung | Lift-off cardboard boxes with foam pad inside and additional protection foam | Boîtes en carton avec intérieur mousse floquée avec découpes et mousse de protection supplémentaire  
Cajas de cartón con interior de espuma con cortes y espuma adicional para tapar



0135 02 UNI   
255 x 50 x 20 mm



0135 44 UNI   
40 x 40 x 18 mm



0135 66 UNI   
60 x 60 x 22 mm



0135 88 UNI   
80 x 80 x 22 mm



0135 39   
158 x 158 x 25 mm



0135 21   
40 x 45 x 30 mm



## FARBEN COLOURS COULEURS COLORES



Seite 4  
Page 4  
Página 4



Abdeckschaum  
Foam pad  
Mousse de protection  
Espuma para tapar

## SPECIAL

TRAGETASCHEN 60  
BAGS 60  
SACS 60  
BOLSAS 60





**Green PACK**  
by **LESER**

**MADE IN GERMANY**

# SERIE 0140 FLOWER

Kartonschachteln mit Schaumstoffeinlage | Lift-off cardboard boxes with foam pads inside  
Boîtes en carton avec intérieur mousse floquée | Cajas de cartón con interior de espuma



0140 21 40 x 45 x 30 mm



0140 39 158 x 158 x 25 mm



0140 44 UNI 40 x 40 x 18 mm



0140 66 UNI 60 x 60 x 22 mm



0140 88 UNI 80 x 80 x 22 mm



FARBEN COLOURS COULEURS COLORES

## SPECIAL

- TRAGETASCHEN 61
- BAGS 61
- SACS 61
- BOLSAS 61



214003



Farbe innen  
Colour inside  
Couleur intérieure  
Color interior







# SERIE 0145 SWITCH

Kartonschachteln mit Schaumstoffeinlage | Lift-off cardboard boxes with foam pad inside  
 Boîtes en carton avec intérieur mousse floquée | Cajas de cartón con interior de espuma



0145 66 UNI    
 60 x 60 x 22 mm

0145 26       
 50 x 50 x 30 mm

0145 88 UNI   
 80 x 80 x 22 mm



0145 39    
 158 x 158 x 25 mm

FARBEN COLOURS COULEURS COLORES

## SPECIAL

TRAGETASCHEN	60
BAGS	60
SACS	60
BOLSAS	60



Farbe innen  
 Colour inside  
 Couleur intérieure  
 Color interior

100%  
RECYCLING



Green PACK  
by LESER



# SERIE 0150 RECYCLE

Kartonschachteln aus recycelten Materialien | Cardboard boxes made from recycled materials  
Écrins en carton fabriqués à partir de matériaux recyclés | Cajas de cartón de materiales reciclados

NEU · NEW · NOUVEAU · NUEVO



0150 66 UNI   
60 x 60 x 22 mm



0150 26   
50 x 50 x 30 mm



0150 39   
158 x 158 x 25 mm



0150 88 UNI   
80 x 80 x 22 mm

FARBEN COLOURS COULEURS COLORES



Farbe innen  
Colour inside  
Couleur intérieure  
Color interior



# SERIE 0230 PLAIN

Kartonschachteln mit Schaumstoffeinlage | Lift-off cardboard boxes with foam pad inside  
Boîtes en carton avec intérieur mousse floquée | Cajas de cartón con interior de espuma



0230 02 UNI   
255 x 50 x 20 mm



0230 66 UNI   
60 x 60 x 22 mm



0230 44 UNI   
40 x 40 x 18 mm



0230 21   
40 x 45 x 30 mm



0230 88 UNI   
80 x 80 x 22 mm



Zusatzeinlage für Armband rund  
Insert for round bracelet  
Cousinet pour bracelet rond  
Interiores para brazaletes redondo

9010 88.003000  
Weiß | white | blanc | blanco  
9010 88.001000  
Schwarz | black | noir | negro



0230 39   
158 x 158 x 25 mm

## FARBEN COLOURS COULEURS COLORES

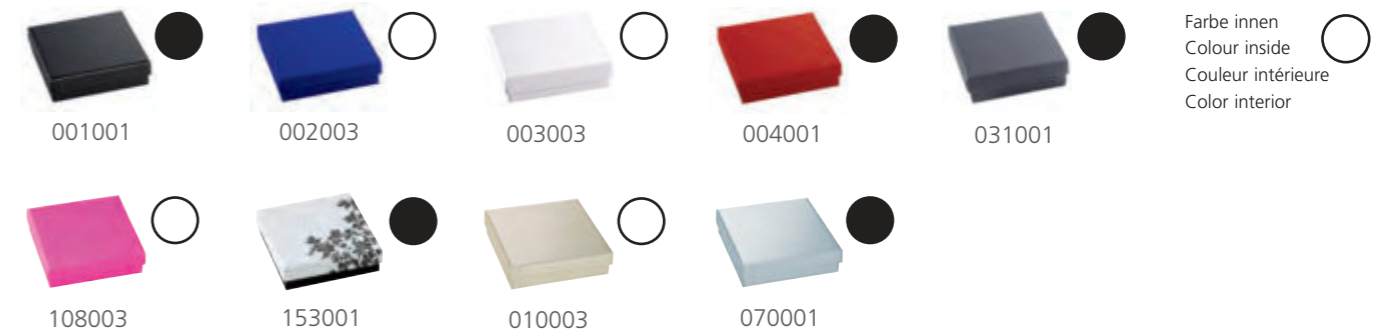

Farbe innen  
Colour inside  
Couleur intérieure  
Color interior



Seite 4  
Page 4  
Página 4

## SPECIAL



TRAGETASCHEN 60  
BAGS 60  
SACS 60  
BOLSAS 60



# SERIE 0255 JOY

Kartonschachteln mit Schaumstoffeinlage und zusätzlicher Schaumstoffabdeckung  
 Lift-off cardboard boxes with foam pad inside and additional flocked foam pad for lid  
 Boîtes en carton avec intérieur mousse floquée avec découpes et mousse de protection supplémentaire  
 Cajas de cartón con interior de espuma con cortes y espuma adicional para tapar



0255 02 UNI    
 255 x 50 x 25 mm



0255 22     
 50 x 50 x 35 mm



0255 88 UNI   
 80 x 80 x 25 mm



0255 66 UNI    
 60 x 60 x 25 mm





Zusatzeinlage für Armband rund  
 Insert for round bracelet  
 Coussinet pour bracelet rond  
 Interiores para brazalete redondo

9010 88.003000  
 Weiß | white | blanc | blanco

9010 88.001000  
 Schwarz | black | noir | negro



0255 39    
 158 x 158 x 25 mm

## FARBEN COLOURS COULEURS COLORES



Abdeckschaum  
 Foam pad  
 Mousse de protection  
 Espuma para tapar



151001



179001

Farbe innen  
 Colour inside  
 Couleur intérieure  
 Color interior



Seite 4  
 Page 4  
 Página 4

## SPECIAL

TRAGETASCHEN 60  
 BAGS 60  
 SACS 60  
 BOLSAS 60





# SERIE 0275 CELEBRATION



Kartonetuis mit Schaumstoffeinlage, Schleifenband mit Magnet fixierbar | Cardboard boxes with foam pad inside, ribbon with magnetic fixation  
Écrins en carton avec intérieur mousse floquée, ruban avec fixation aimantée | Estuches de cartón con interior de espuma, cinta con fijación magnética



0275 28   
65 x 42 x 30 mm

0275 88    
80 x 80 x 25 mm



0275 22     
50 x 50 x 30 mm

Zusatzeinlage für Armband rund  
Insert for round bracelet  
Coussinet pour bracelet rond  
Interiores para brazalete redondo  
**9010 88.003000**  
Weiß | white | blanc | blanco  
**9010 88.001000**  
Schwarz | black | noir | negro

0275 39    
158 x 158 x 30 mm



FARBEN COLOURS COULEURS COLORES



<b>SPECIAL</b>					Farbe innen Colour inside Couleur intérieure Color interior 
TRAGETASCHEN	60/61				
BAGS	60/61				
SACS	60/61				
BOLSAS	60/61				
			004001		010010



# SERIE 0276 LOOP

Kartonschachteln mit Schaumstoffeinlage und Schleifenband | Cardboard boxes with foam pad inside and ribbon  
Écrins en carton avec intérieur mousse floquée et ruban | Estuches de cartón con interior de espuma y cinta







0276 02     
255 x 50 x 20 mm

0276 88    
80 x 80 x 22 mm

0276 21     
40 x 45 x 30 mm

0276 39    
158 x 158 x 25 mm

FARBEN COLOURS COULEURS COLORES

<b>SPECIAL</b>					Farbe innen Colour inside Couleur intérieure Color interior 
TRAGETASCHEN	60				
BAGS	60				
SACS	60				
BOLSAS	60				
			001001		

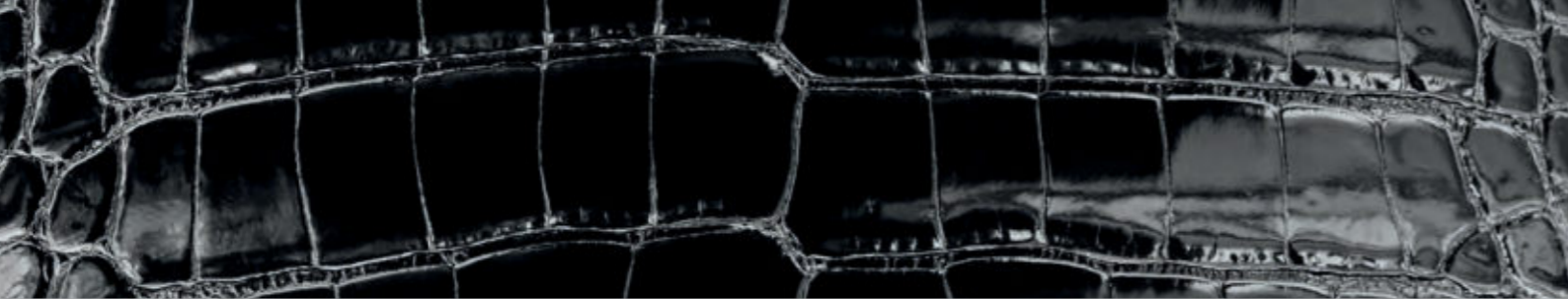

# SERIE 0280 CROCO

Überzogene Kartonschachteln mit Schaumstoffeinlage und zusätzlicher Schaumstoffabdeckung  
 Covered cardboard boxes with foam pad inside and additional flocked foam pad for lid  
 Écrins en carton avec intérieur mousse floquée avec découpes et mousse de protection supplémentaire  
 Cajas de cartón forradas con interior de espuma y espuma adicional para tapar



0280 21 50 x 50 x 35 mm



0280 66 UNI 60 x 60 x 26 mm



0280 89 UNI 85 x 85 x 60 mm



0280 40 180 x 180 x 32 mm



0280 88 UNI 80 x 80 x 26 mm



Zusatzeinlage für Armband rund  
 Insert for round bracelet  
 Coussinet pour bracelet rond  
 Interiores para brazaletes redondo  
**9010 88.003000**  
 Weiß | white | blanc | blanco  
**9010 88.001000**  
 Schwarz | black | noir | negro

## FARBEN COLOURS COULEURS COLORES

### SPECIAL

- TRAGETASCHEN 61
- BAGS 61
- SACS 61
- BOLSAS 61



Abdeckschaum  
 Foam pad  
 Mousse de protection  
 Espuma para tapar



001001



Farbe innen  
 Colour inside  
 Couleur intérieure  
 Color interior



# SERIE 0735 LINE

Kartonetuis mit Schaumstoffeinlage und Einschlagtuch  
 Cardboard boxes with foam pad inside and velvet cloth inside  
 Écrins en carton avec intérieur mousse floquée avec découpes et voile d'enveloppe  
 Estuches de cartón con interior de espuma y tejido



0735 02 UNI   
 255 x 50 x 25 mm



0735 66 UNI   
 60 x 60 x 25 mm



0735 88 UNI   
 80 x 80 x 25 mm



Zusatzeinlage für Armband rund  
 Insert for round bracelet  
 Coussinet pour bracelet rond  
 Interiores para brazaletes redondo

9010 88.003000  
 Weiß | white | blanc | blanco

9010 88.001000  
 Schwarz | black | noir | negro



0735 21   
 50 x 50 x 35 mm

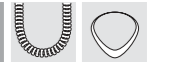

0735 39   
 158 x 158 x 25 mm

## FARBEN COLOURS COULEURS COLORES



071001



073003



191005



239001

Farbe innen  
 Colour inside  
 Couleur intérieure  
 Color interior



Seite 4  
 Page 4  
 Página 4

## SPECIAL

TRAGETASCHEN 60  
 BAGS 60  
 SACS 60  
 BOLSAS 60





# SERIE 0830 CASE

Schuberbox mit Schaumstoffeinlage und zusätzlicher Schaumstoffabdeckung  
 Drawer box with foam pad inside and additional flocked foam pad for lid  
 Ecrin tiroir avec intérieur mousse floquée avec découpes et mousse de protection supplémentaire  
 Estuche cajón con interior de espuma con cortes y espuma adicional para tapar



0830 26     
 55 x 50 x 32 mm



0830 39    
 165 x 150 x 32 mm



0830 88 UNI   
 95 x 85 x 32 mm

FARBEN COLOURS COULEURS COLORES



Seite 4  
 Page 4  
 Página 4

## SPECIAL

TRAGETASCHEN	60
BAGS	60
SACS	60
BOLSAS	60



Abdeckschaum  
 Foam pad  
 Mousse de protection  
 Espuma para tapar

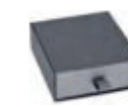

193008



Farbe innen  
 Colour inside  
 Couleur intérieure  
 Color interior







**Green PACK**  
by **LESER**

 **MADE IN GERMANY**

# SERIE 1560 EARTH

Schachteln aus **Biokunststoff**, einem nachwachsenden, pflanzlichen Rohstoff  
 Lift-off boxes made of bioplastic, a regrowing plant-derived raw material  
 Boîtes en bioplastique, une matière première végétale renouvelable  
 Cajas de bioplástico, materia prima de origen vegetal renovable

**BIO-Kunststoffschachteln** mit Schaumstoffeinlage | Lift-off plastic boxes with foam pad inside  
 Boîtes plastiques avec intérieur mousse floquée | Cajas de plástico con espuma



**1560 66** UNI   
60 x 60 x 22 mm



**1560 21**   
40 x 45 x 30 mm



**1560 44** UNI   
40 x 40 x 18 mm



**1560 88** UNI   
80 x 80 x 22 mm



Zusatzeinlage für Armband rund  
 Insert for round bracelet  
 Coussinet pour bracelet rond  
 Interiores para brazaletes redondo

**9010 88.003000**  
 Weiß | white | blanc | blanco  
**9010 88.001000**  
 Schwarz | black | noir | negro





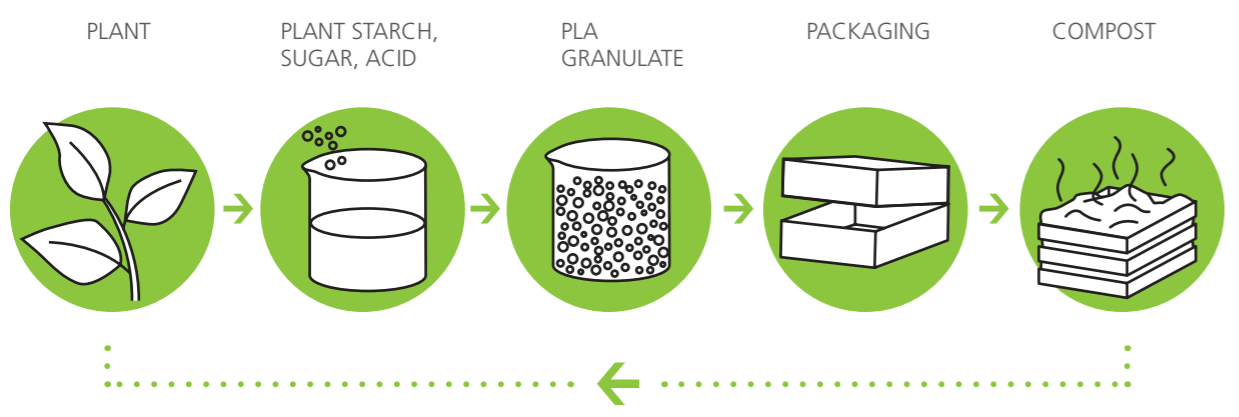





**1560 37**   
158 x 158 x 25 mm

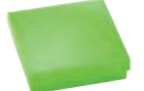

FARBEN COLOURS COULEURS COLORES

**+ DECOR**

Seite 4  
Page 4  
Página 4

 001001		 003003		Farbe innen Colour inside Couleur intérieure Color interior
 006003		 044003		

# SERIE 1700 FUTURA

Kunststoffschachteln mit Watte | Lift-off plastic boxes with cotton inside  
Boîtes plastiques avec intérieur ouate | Cajas de plástico con guata

**100% recycelter Kunststoff**

100% recycled plastic  
100% plastique recyclé  
100% plástico reciclado

**NEW**



1700 66 UNI    
60 x 60 x 20 mm



1700 44 UNI   
40 x 40 x 16 mm



1700 88 UNI   
80 x 80 x 22 mm



1700 37 UNI    
160 x 160 x 25 mm

FARBEN COLOURS COULEURS COLORES



**NEW**





001003



**NEW**



002003

Farbe innen   
Colour inside   
Couleur intérieure   
Color interior 



# SERIE 1750 FUTURA S

Kunststoffschachteln mit Schaumstoffeinlage | Lift-off plastic boxes with foam pad inside  
 Boîtes plastiques avec intérieur mousse floquée | Cajas de plástico con espuma



1750 03 UNI   
 208 x 30 x 18 mm



1750 02 UNI    
 242 x 46 x 17 mm





1750 66 UNI    
 60 x 60 x 20 mm



1750 88 UNI   
 80 x 80 x 22 mm





1750 21     
 42 x 42 x 33 mm



1750 44 UNI   
 40 x 40 x 16 mm



1750 37    
 160 x 160 x 25 mm

FARBEN COLOURS COULEURS COLORES



Farbe innen  
 Colour inside  
 Couleur intérieure  
 Color interior

**SPECIAL**

- TRAGETASCHEN 60
- BAGS 60
- SACS 60
- BOLSAS 60



T R A N S L U T I O N





# SERIE 2250 SHINE

Kunststoffetuis mit Schaumstoffeinlage | Hinged plastic boxes with foam pad inside  
Écrins plastiques avec intérieur mousse floquée | Estuches de plástico con espuma



2250 02 UNI   
243 x 50 x 18 mm



2250 09   
80 x 80 x 21 mm



2250 07   
60 x 60 x 18 mm



2250 08   
55 x 83 x 20 mm



2250 44 UNI   
45 x 45 x 18 mm



2250 21   
40 x 45 x 32 mm

2250 37   
160 x 185 x 22 mm

## FARBEN COLOURS COULEURS COLORES



Seite 4  
Page 4  
Página 4



042003



043001



068003\*

Farbe innen  
Colour inside  
Couleur intérieure  
Color interior



# SERIE 5100 ELEGANCE

Hochwertig überzogene Etuis mit schmuckbezogener Einlage | Boxes covered with up-market Skivertex and pad for jewellery inside  
 Écrins haut de gamme recouverts de Skivertex avec intérieur de luxe | Estuches forradas de polipiel de alta calidad con interior de gran valor



5100 07   
60 x 60 x 22 mm



5100 23   
40 x 45 x 30 mm



5100 09   
80 x 80 x 22 mm



5100 39   
165 x 165 x 25 mm



5100 29   
50 x 55 x 32 mm

## FARBEN COLOURS COULEURS COLORES

### SPECIAL

- TRAGETASCHEN 61
- BAGS 61
- SACS 61
- BOLSAS 61



001001



004003

Farbe innen  
 Colour inside  
 Couleur intérieure  
 Color interior





# SERIE 5510 POESIE

Hochwertig überzogene Etuis mit schmuckbezogener Einlage | Boxes covered with up-market Skivertex and pad for jewellery inside  
 Écrins haut de gamme recouverts de Skivertex avec intérieur de luxe | Estuches forradas de polipiel de alta calidad con interior de gran valor



5510 39    
 165 x 159 x 29 mm



5510 16    
 42 x 41 x 26 mm



5510 03   
 216 x 46 x 18 mm



5510 64   
 59 x 59 x 20 mm



5510 25   
 42 x 41 x 32 mm



5510 29   
 69 x 41 x 31 mm



5510 09     
 82 x 82 x 27 mm

## FARBEN COLOURS COULEURS COLORES



001001



002003\*



180001



244001

Farbe innen  
 Colour inside  
 Couleur intérieure  
 Color interior

## SPECIAL

- TRAGETASCHEN 60
- BAGS 60
- SACS 60
- BOLSAS 60





# SERIE 5520 STRAIGHT

Hochwertig überzogene Etuis mit schmuckbezogener Einlage und Deckelkissen aus Seide, incl. einer weißen Schiebehülle.  
**Überzug und Seide aus 100% recyceltem Material.**  
 Premium boxes with pad for jewellery and silk lid cushion, inclusive white sleeve. Cover and silk made of 100% recycled material.  
 Ecrins gainés main qualitatifs fabriqués à partir de matériaux 100% recyclés comme le revêtement extérieur et la soie en fond de couvercle.  
 Estuches forradas con interior lujo, cojín de seda en la tapa, funda blanca inclusive. Forro y seda de material completamente reciclado.



5520 39    
165 x 159 x 29 mm



5520 16    
42 x 41 x 26 mm



5520 03   
216 x 46 x 18 mm



5520 09     
82 x 82 x 27 mm



5520 29   
69 x 41 x 31 mm



5520 64   
59 x 59 x 20 mm



5520 25   
42 x 41 x 32 mm

FARBEN COLOURS COULEURS COLORES

## SPECIAL

- TRAGETASCHEN 60
- BAGS 60
- SACS 60
- BOLSAS 60



001001

Farbe innen  
Colour inside  
Couleur intérieure  
Color interior



# SERIE 5530 BRILLIANT

Hochwertiges Etui mit metallischem Überzug und schmuckbezogener Einlage, inklusive einem hochwertigen Umkarton  
 Premium box with metallic coating with a pad for jewellery inside, covering box in same colour  
 Écrins gainés avec matériau haut de gamme et intérieur de luxe. Surboîte de même couleur  
 Estuches de alta calidad con interior lujo, con caja exterior en el mismo color



5530 39    
135 x 193 x 27 mm





5530 29    
75 x 45 x 40 mm



5530 27   
54 x 48 x 40 mm



5530 16    
54 x 48 x 40 mm



5530 64   
64 x 70 x 23 mm



5530 03   
215 x 45 x 24 mm

## HIGHLIGHT



### Ringetuis mit LED-Beleuchtung

Box for rings with LED light  
 Écrins avec éclairage LED  
 Estuches sortija con saja con iluminación led



5530 23   
54 x 48 x 40 mm



5530 30    
75 x 45 x 40 mm  
 Nur in Creme und Schwarz  
 Only in cream and black  
 Seulement en crème et noir  
 Sólo en crema y negro

### FARBEN COLOURS COULEURS COLORES



001001



010010



221221

Farbe innen  
 Colour inside  
 Couleur intérieure  
 Color interior

### SPECIAL

TRAGETASCHEN 60  
 BAGS 60  
 SACS 60  
 BOLSAS 60







# SERIE 5850 SOFT TOUCH

Hochwertig überzogene Etuis mit Nappa-Leder-Imitat und schmuckbezogener Einlage inkl. weißem Umkarton  
 Premium boxes covered with artificial leather and pad for jewellery, inclusive white covering box  
 Écrins haut de gamme recouverts d'imitation Nappa avec intérieur de luxe et surboîte blanc  
 Estuches forradas de imitación de piel de alta calidad, con interior de gran valor, incl. caja de cartón blanco



5850 03   
 213 x 42 x 24 mm



5850 25   
 45 x 45 x 40 mm



5850 39    
 165 x 177 x 29 mm





5850 64   
 54 x 58 x 21 mm





5850 09     
 80 x 80 x 26 mm



5850 27    
 80 x 80 x 26 mm



5850 16    
 45 x 45 x 26 mm

FARBEN COLOURS COULEURS COLORES

## SPECIAL

- TRAGETASCHEN 60
- BAGS 60
- SACS 60
- BOLSAS 60



001001



005010

Farbe innen  
 Colour inside  
 Couleur intérieure  
 Color interior



# SERIE 5880 ALORS

Hochwertig überzogene Etuis mit Velours-Leder-Imitat und schmuckbezogener Einlage inkl. schwarzem Umkarton  
 Premium boxes covered with artificial velours and pad for jewellery, inclusive black covering box  
 Écrins haut de gamme recouverts d'imitation velours avec intérieur de luxe et surboîte noire  
 Estuches forradas de antelina de alta calidad, con interior de gran valor, incl. caja de cartón negro





5880 03   
 213 x 42 x 24 mm





5880 25   
 45 x 45 x 40 mm





5880 09    
 80 x 80 x 26 mm



5880 39    
 165 x 177 x 29 mm



5880 27    
 80 x 80 x 26 mm



5880 64   
 54 x 58 x 21 mm

FARBEN COLOURS COULEURS COLORES

## SPECIAL

TRAGETASCHEN	60
BAGS	60
SACS	60
BOLSAS	60



001001



Farbe innen   
 Colour inside  
 Couleur intérieure  
 Color interior

# SERIE 5890 ATTICO

Hochwertig überzogenes Etui mit Leder-Imitat und schmuckbezogener Einlage, inklusive schwarzem Umkarton.  
 Premium boxes covered with leatherette and pad for jewellery, inclusive black covering box  
 Écrins haut de gamme recouverts d'imitation cuir avec intérieur de luxe et surboîte noire  
 Estuches forradas de polipiel de alta calidad, con interior de gran valor, incl. caja de cartón exterior negro





5890 09    
82 x 77 x 28 mm

5890 39    
180 x 174 x 32 mm



5890 64   
62 x 57 x 25 mm

5890 27    
82 x 77 x 28 mm

5890 25   
55 x 48 x 40 mm

FARBEN COLOURS COULEURS COLORES

## SPECIAL

TRAGETASCHEN	60
BAGS	60
SACS	60
BOLSAS	60



001001

Farbe innen  
 Colour inside  
 Couleur intérieure  
 Color interior



# SERIE 5950 FRAME

Überzogene Kunststoff-Rahmenetuis mit Siliconmembran | Covered frame boxes with silicone membrane  
 Écrin recouvert en forme de cadre avec deux membranes en silicone | Estuche forrado, en forma de cuadro, y membrana central de silicona



5950 40 UNI   
 Int. 180 x 230 x 35 mm  
 Ext. 223 x 270 x 43 mm



5950 03 UNI   
 Int. 220 x 40 x 25 mm  
 Ext. 250 x 72 x 32 mm



5950 02 UNI   
 Int. 265 x 60 x 25 mm  
 Ext. 294 x 92 x 34 mm



5950 44 UNI   
 Int. 50 x 50 x 25 mm  
 Ext. 80 x 83 x 34 mm



5950 88 UNI  
 Int. 100 x 100 x 25 mm  
 Ext. 130 x 133 x 34 mm



5950 20 UNI   
 Int. 173 x 123 x 28 mm  
 Ext. 205 x 158 x 37 mm



5950 36 UNI   
 Int. 150 x 150 x 25 mm  
 Ext. 180 x 183 x 34 mm



5950 66 UNI  
 Int. 70 x 70 x 25 mm  
 Ext. 100 x 103 x 34 mm



FARBEN COLOURS COULEURS COLORES

## SPECIAL

PASSEND ZUR SEITE 77  
 APPLICABLE FOR DISPLAY - PAGE 77  
 ADAPTÉ AU PRÉSENTOIR - PAGE 77  
 ADECUADO PARA EL DISPLAY EN PÁGINA 77



001900



003900

Farbe innen  
 Colour inside  
 Couleur intérieure  
 Color interior



# SERIE 6410 BLACKWOOD

Holzetuis mit hochwertiger schmuckbezogener Einlage; inklusive schwarzem Umkarton  
 Wooden boxes with top quality interior; inclusive black covering box  
 Écrins en bois avec coussinet de luxe et surboîte noire  
 Estuches de madera con interior de alta calidad; incl. caja exterior negra



6410 39 UNI   
 194 x 191 x 46 mm



6410 88 UNI   
 65 x 62 x 46 mm

Multifunktionale Einlage  
 Multifunctional insert  
 Intérieur multi-usage  
 Interior multi uso



6410 89 UNI   
 90 x 87 x 46 mm

FARBEN COLOURS COULEURS COLORES

**SPECIAL**

TRAGETASCHEN	60
BAGS	60
SACS	60
BOLSAS	60



● Farbe innen  
 ○ Colour inside  
 ● Couleur intérieure  
 ○ Color interior

111001



9905 01.111001  
150 x 150 x 90 mm



9903 04.008008  
95 x 95 x 75 mm



6400 06.111001  
95 x 95 x 73 mm



9909 03.132001  
82 x 95 x 64 mm



9909 03.001001  
82 x 95 x 64 mm



9909 33.001001  
100 x 95 x 64 mm



0130 89.001001  
85 x 85 x 60 mm



0130 89.003003  
85 x 85 x 60 mm



1750 06.001001  
90 x 90 x 70 mm



1750 06.060003  
90 x 90 x 70 mm



0761 88.001001  
84 x 87 x 55 mm



0130 06.001001  
90 x 90 x 70 mm



5100 02.001001  
243 x 52 x 22 mm

**ANTRAGSRING ENGAGEMENT RING**  
**BAGUE DE FIANÇAILLES ANILLO DE COMPROMISO**

**TRAURINGE WEDDING RINGS**  
**ALLIANCES ALIANZAS**



**5510 24.001001**  
 42 x 41 x 26 mm  
 Seite 40-41 | page | página



**5510 25\***  
 42 x 41 x 32 mm  
 Seite 40-41 | page | página



**5520 25**  
 42 x 41 x 32 mm  
 Seite 42-43 | page | página



**5100 23\***  
 40 x 45 x 30 mm  
 Seite 38-39 | page | página

**1900 21.075003**  
 51 x 48 x 33 mm



**1900 08.075003**  
 80 x 70 x 36 mm

**0275 28\***  
 65 x 42 x 30 mm  
 Seite 22 | page | página



**5530 30\***  
 75 x 45 x 40 mm  
 Seite 44-45 | page | página



**6410 29.103003**  
 90 x 70 x 17 mm



**6410 88.111001**  
 65 x 62 x 46 mm  
 Seite 54-55 | page | página



**5850 25\***  
 45 x 45 x 40 mm  
 Seite 46-47 | page | página



**5890 25.001001**  
 55 x 48 x 40 mm  
 Seite 50-51 | page | página



**5530 27\***  
 54 x 48 x 40 mm  
 Seite 44-45 | page | página



**5530 29\***  
 75 x 45 x 40 mm  
 Seite 44-45 | page | página



**5300 60.001001**  
 **5300 60.003003**  
 75 x 50 x 17 mm



**6410 88.111001**  
 65 x 62 x 46 mm  
 Seite 54-55 | page | página



**5300 61.001001**  
 **5300 61.003003**  
 60 x 40 x 30 mm



**Jetzt mit LED-Beleuchtung**  
 Now with LED light  
 Désormais avec éclairage LED  
 Ahora con iluminación led

**5530 23\***  
 54 x 48 x 40 mm  
 Seite 44-45 | page | página



**5511 29.003003**  
 82 x 82 x 27 mm



**5100 30.003003**  
 75 x 50 x 15 mm



**5510 30.070001**  
 71 x 39 x 32 mm



**5510 30.010003**  
 71 x 39 x 32 mm

# TRAGETASCHEN

# BAGS SACS PAPIER BOLSAS



**9250 55**  
195 x 80 x 265 mm



**9250 53**  
130 x 60 x 190 mm

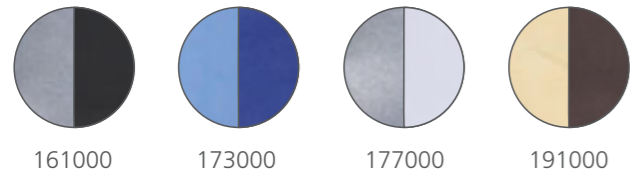

**9250 55**  
195 x 80 x 265 mm



**9250 53**  
130 x 60 x 190 mm

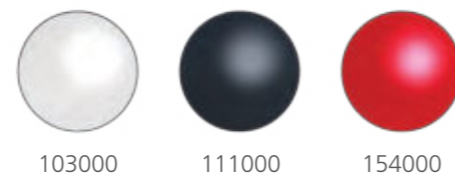

**9250 59.008003**  
240 x 105 x 270 mm

**9250 59.001000**  
240 x 105 x 270 mm



**9250 39.008003**  
110 x 40 x 165 mm

**9250 39.001000**  
110 x 40 x 165 mm



**9250 57.205000**  
230 x 100 x 300 mm



**9250 29.103000**  
300 x 100 x 250 mm



**9250 39.004000**  
110 x 40 x 165 mm



**9250 30.103000**  
190 x 80 x 260 mm



**9250 55.217000**  
195 x 80 x 265 mm





**9909 52.099001**  
83 x 83 x 30 mm

Set à 6 farblich sortiert (3 Farben)  
Set 6 pieces colour-assorted (3 colours)  
Set à 6 pièces (assortiment de 3 couleurs)  
Juego de 6 piezas (en 3 colores)



**9909 52.001001**  
83 x 83 x 30 mm

Set à 6 Stück  
Set 6 pieces  
Set à 6 pièces  
Juego de 6 piezas



**0731 45.001001**  
213 x 157 x 40 mm



**0731 50.001001**  
230 x 100 x 30 mm



230 x 100 x 15 mm



230 x 100 x 15 mm



230 x 100 x 15 mm

Zusatzlagen  
Additional inserts  
Coussinets  
Interiores adicionales

**9001 53.001000**  
5 Ringe | 5 Rings | 5 Bagues | 5 Anillos

**9001 52.001000**  
20 Ringe | 20 Rings | 20 Bagues | 20 Anillos

**9001 51.001000**  
Universal, Set

**FIXBOXEN FIX BOXES BOÎTES CARTONNÉES FIX BOX**  
**SCHMUCKTÜTEN JEWELLERY BAGS POCHETTES DE BIJOUX SOBRES PAPEL**  
**SCHMUCKBEUTEL JEWELLERY BAGS BOURSES SUÉDINES BOLSAS PARA JOYERÍA**

9310 40.001000  
Ø 50 mm



9310 41.001000  
Ø 65 mm

9310 42.001000  
Ø 85 mm

9300 61.108000  
52 x 52 x 80 mm

9300 61.009000  
52 x 52 x 80 mm

9300 81.108000  
78 x 78 x 100 mm

9300 81.009000  
78 x 78 x 100 mm



9300 37.001000  
30 x 40 mm



9300 52.003000  
80 x 120 mm



9300 52.001000  
80 x 120 mm

9300 01.001000  
78 x 86 mm

9300 02.001000  
95 x 109 mm

9300 03.001000  
112 x 125 mm

9300 04.001000  
141 x 147 mm



9300 54.001000\*  
90 x 150 mm



9300 54.163000\*  
90 x 150 mm



9300 54.108000\*  
90 x 150 mm

9200 01  
78 x 113 mm

9200 02  
102 x 148 mm

9200 03  
111 x 173 mm



9350 22  
71 x 74 x 22 mm

9350 23  
78 x 100 x 37 mm

9350 27  
105 x 135 x 45 mm



FARBEN COLOURS COULEURS COLORES



003000

001000

**SERIE 5315 Present Box**



5315 35.213000  
35 x 85 mm



5315 55.215000  
55 x 85 mm



5315 90.183999

Display PresentBox - bestückt mit 9 x Box klein, 7 x Box groß  
 Display PresentBox - with 9 x Box small, 7 x Box big  
 Présentoir PresentBox - équipé de 9 petites box et de 7 grandes Box  
 Display PresentBox - equipado con 9 x caja pequeña, 7 x caja grande



9001 55.003000  
9001 55.001000

Einlagen passend für Art. 5315 55  
 Inserts for art. 5315 55  
 Inserts adaptés à l'art. 5315 55  
 interiores adicionales para ref. 5315 55

**SERIE 9350 FIX-BOX**



9350 60.004000  
65 x 65 x 40 mm



9350 60.153000  
65 x 65 x 40 mm



9300 40.003000  
70 x 35 mm



9350 61.004000  
85 x 85 x 35 mm



9350 61.153000  
85 x 85 x 35 mm



**Ringtui für bewegende Momente**  
 Ring case for moving moments  
 Une bague pour des moments émouvants  
 Estuche de anillo para momentos emocionantes



**NEW**

**9909 60.010010**  
 Aussenmaß Etui 69 x 69 mm  
 Höhe 70 mm



**0130 66.223003**  
 60 x 60 x 22 mm



**0130 26.006001**  
 50 x 50 x 30 mm

**0130 26.052001**  
 50 x 50 x 30 mm



**0130 26.002001**  
 50 x 50 x 30 mm



**0130 40.031001**  
 190 x 190 x 35 mm



**8080 71**  
**8080 PRICE-SYSTEM**



**8080 81**

**5960 36.001900**  
 Int. 150 x 150 x 20 mm  
 Ext. 180 x 183 x 27 mm



**5960 66.001900**  
 Int. 70 x 70 x 20 mm  
 Ext. 100 x 103 x 27 mm

**5960 88.001900**  
 Int. 100 x 100 x 20 mm  
 Ext. 130 x 133 x 27 mm



**5960 88.003900**  
 Int. 100 x 100 x 20 mm  
 Ext. 130 x 133 x 27 mm

**5960 88.002900**  
 Int. 100 x 100 x 20 mm  
 Ext. 130 x 133 x 27 mm

SERIE 9100

SERIE 9400

**NEW**

**Auch 4-farbig möglich**  
 Also available in 4 colours  
 4 couleurs également possible  
 También posible en 4 colores



**LESER**  
 PACKAGING & MORE

**LESER**

**LESER**

**LESER**



**LESER**

**LESER**

**LESER**



**8001 03**  
207 x 175 x 400 mm



**8001 02**  
150 x 140 x 300 mm



**8001 01**  
113 x 100 x 200 mm



**8001 21**  
35 x 20 x 25 mm



**8001 22**  
40 x 30 x 50 mm



**8001 23**  
60 x 40 x 90 mm



**8001 11**  
30 x 40 mm



**8001 12**  
30 x 60 mm



**8001 31**  
40 x 30 x 55 mm



**8001 41**  
50 x 40 x 70 mm

FARBEN COLOURS COULEURS COLORES



001000



003000



**8002 60**  
350 x 250 x 19,5 mm



**8002 61**  
450 x 350 x 19,5 mm

**8002 30**  
105 x 245 x 50 mm  
Nur in Weiß  
only in white  
seulement en blanc  
sólo en blanco



**8002 31**  
105 x 245 x 50 mm  
Nur in Weiß  
only in white  
seulement en blanc  
sólo en blanco



**8002 03**  
150 x 40 x 250 mm



**8002 02**  
125 x 40 x 200 mm



**8002 01**  
100 x 40 x 150 mm



**8002 42**  
30 x 30 x 90 mm



**8002 12**  
30,5 x 30,5 x 60 mm



**8002 11**  
30,5 x 30,5 x 40 mm



**8002 10**  
30,5 x 30,5 x 20 mm



**8002 41**  
30 x 30 x 70 mm



**8002 22**  
40 x 30 x 50 mm



**8002 21**  
40 x 20 x 25 mm

FARBEN COLOURS COULEURS COLORES

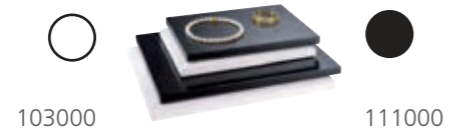

103000

111000

FARBEN COLOURS COULEURS COLORES



103000

111000



Magnethaftung  
magnetic adhesive  
adhérence magnétique  
fijación magnética



**8003 65**  
305 x 110 x 360 mm



**8003 61**  
380 x 380 x 15 mm



**8003 02**  
100 x 38 x 202 mm



**8003 01**  
75 x 38 x 152 mm



**8003 80**  
110 x 16 x 55 mm



**8003 90**  
Ø 16 x 25 mm



**8003 10**  
35 x 35 x 20 mm



**8003 11**  
35 x 35 x 40 mm



**8003 12**  
35 x 35 x 60 mm



**8003 21**  
50 x 28 x 22 mm



**8003 31**  
70 x 28 x 22 mm

FARBEN COLOURS COULEURS COLORES



201000



203000



**8440 23\***  
310 x 288 mm

**8440 50\*\***  
250 x 140 x 100 mm

**8441 57**  
100 x 30 x 250 mm

**8441 58**  
100 x 30 x 197 mm

**8440 89**  
32 x 30 x 20/40/60 mm

**8440 51\*\***  
120 x 100 x 50 mm

**8440 24\***  
310 x 188 mm

**8441 59**  
95 x 30 x 138 mm

FARBEN COLOURS COULEURS COLORES



919000



921000



923000



922000



924000

\* Nur in Schwarz und Weiss | only in black and white | seulement en noir et blanc | sólo en negro y blanco

\*\* Nur in Weiss | only in white | seulement en blanc | sólo en blanco

\*\*\* Nur solange Vorrat reicht | Only while supplies last | Dans la limite des stocks disponibles | Disponibilidad hasta agotar existencias



**8006 07**  
210 x 140 x 275 mm



**8006 06**  
190 x 110 x 225 mm



**8006 05**  
130 x 90 x 170 mm



**8006 10**  
Ø 50 mm  
Höhe 80/65/50 mm  
Ringset 3tlg.  
Ring column set 3 parts  
Support bague set à 3 pièces  
Surtido de 3 soportes anillo



**8006 03**  
15 x 25 x 10 mm



**8006 21**  
Ø 28 mm  
Höhe 90/75/60/45/30 mm  
Ringset 5tlg.  
Ring column set 5 parts  
Support bague set à 5 pièces  
Surtido de 5 soportes anillo



**8006 11**  
25 x 25 x 12 mm



**8006 12**  
24 x 24 x 54 mm



**8006 25**  
Ø 37 mm



**8006 44**  
30 x 24 x 38 mm



**8006 45**  
35 x 20 x 48 mm



**8006 41**  
31 x 17 x 19 mm



**8006 42**  
36 x 19 x 36 mm



**8006 43**  
38 x 29 x 53 mm



**8006 50**  
52 x 27 x 81 mm



**8006 82**  
75 mm hoch



**8006 83**  
90 mm hoch



**8006 61**  
34 x 20 x 27 mm



**8006 62**  
40 x 25 x 38 mm



**8006 63**  
48 x 35 x 62 mm



**8006 64**  
50 x 35 x 70 mm



**8006 81**  
100 x 100 mm



**8006 80**  
26 x 170 x 54 mm

# SERIE 8000 BUST



**8000 12\***  
190 x 150 x 175 mm



**8000 13\***  
155 x 125 x 140 mm



**8000 14\***  
122 x 90 x 110 mm



**8000 50\***  
110 x 70 x 190 mm



**8000 51\***  
141 x 84 x 260 mm



**8000 52\***  
193 x 105 x 340 mm



**8000 24\***  
180 x 140 x 240 mm



**8000 25\***  
220 x 200 x 290 mm

\* Nur in Schwarz und Weiss | only in black and white | seulement en noir et blanc | sólo en negro y blanco



**8000 06**  
110 x 120 x 115 mm



**8000 08**  
135 x 145 x 125 mm



**8000 09**  
160 x 175 x 165 mm

mögliche Farbauswahl - Seite 77  
available colours - page 77  
couleurs possibles - page 77  
posibles colores - página 77

# SERIE 9935 FRAME



Präsentationselement  
Stand for presentation  
Élément de présentation  
Elemento de presentación

**50 mm: 9935 41.921000\***  
50 x 12 x 50 mm

**125 mm: 9935 42.921000\***  
50 x 12 x 125 mm

**200 mm: 9935 43.921000\***  
50 x 12 x 200 mm

Bodenplatte  
Bottom plate  
Plateau de fond  
Placa de base

**9935 40.921000\***  
400 x 200 x 18 mm

Etuis - Seite 52-53  
Boxes - page 52-53  
Écrins - page 52-53  
Estuches - página 52-53

\* Nur solange Vorrat reicht | Only while supplies last | Dans la limite des stocks disponibles | Disponibilidad hasta agotar existencias

# FARBEN COLOURS COULEURS COLORES

DEKO-SYSTEME DECO SYSTEMS SYSTÈMES DÉCORATIFS SISTEMAS DE DECORACIÓN

## ROMA



## TOP SOFT



Sonderfarben auf Anfrage | Custom colours available upon request | Autres couleurs sur demande | Colores especiales a petición



BASIC



8030 75 ①  
8030 76 ②  
8030 77 ③  
8030 78 ④  
300 x 130 x 415 mm



8030 70 ①  
8030 71 ②  
8030 72 ③  
8030 73 ④  
240 x 110 x 315 mm

STRAIGHT



8030 26  
190 x 90 x 294 mm



8030 25  
192 x 100 x 206 mm

SWING



8030 80 ①  
8030 81 ②  
  
8030 82 ①  
8030 83 ②  
  
8030 84 ①  
8030 85 ②  
  
310 x 208 x 310 mm

DOME



8030 01 ①  
8030 02 ②  
300 x 70 x 320 mm

BOARD



8030 40 ①  
8030 41 ②  
8030 42 ③  
8030 43 ④  
170 x 115 x 395 mm



8040 03  
370 x 265 x 10 mm



8040 04  
370 x 245 x 15 mm



8040 45  
400 x 260 x 30 mm



8040 44  
225 x 225 x 30 mm



8040 01\*  
500 x 170 x 15 mm



8040 02  
500 x 400 mm

mögliche Farbauswahl - Seite 77 · available colours - page 77 · couleurs disponibles - page 77 · posibles colores - página 77



① Standard · standard · standard · estándar



② Preishalter für DELTA-Ziffern · price holders for DELTA-numbers · support prix pour chiffres DELTA · soportes numeraciones DELTA



③ Öffnungen für Preisetiketten · holes for price tags · ouverture pour support prix · aberturas para etiquetas



④ Preishalter für DELTA-Ziffern und Öffnungen für Preisetiketten · price holders for DELTA-numbers and holes for price tags · support prix et support pour chiffres DELTA · soportes numeraciones DELTA y aberturas para etiquetas

mögliche Farbauswahl - Seite 77  
available colours - page 77  
couleurs disponibles - page 77  
posibles colores - página 77

\* Nur in Schwarz | only in black | seulement en noir | sólo en negro

# SERIE 8045 TRAY SYSTEM



Tablets 8045 01/02 auch in weiß erhältlich  
 Trays 8045 01/02 also available in white  
 Plateaux 8045 01/02 disponibles aussi en blanc  
 Bandejas 8045 01/02 también disponibles en blanco

Tablett 8045 19.944948  
 150 x 150 x 40 mm  
 Nur in Weiß  
 Only in white  
 Seulement en blanc  
 Sólo en blanco

Wendeeinlage  
 Insert double side  
 Insert 2 faces  
 Interior 2 caras

## Vorlagetablets tray | plateau carré | bandeja

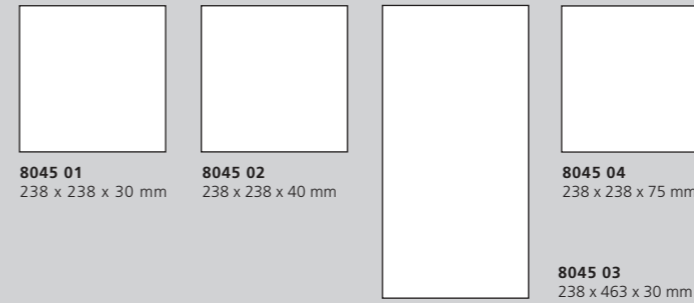

**8045 01**  
238 x 238 x 30 mm

**8045 02**  
238 x 238 x 40 mm

**8045 03**  
238 x 463 x 30 mm

**8045 04**  
238 x 238 x 75 mm

## Tiefzieheinlage\* vacuum formed insert | intérieur thermo | interior termoformado

## Kartusche\* pad | intérieur | almohadilla

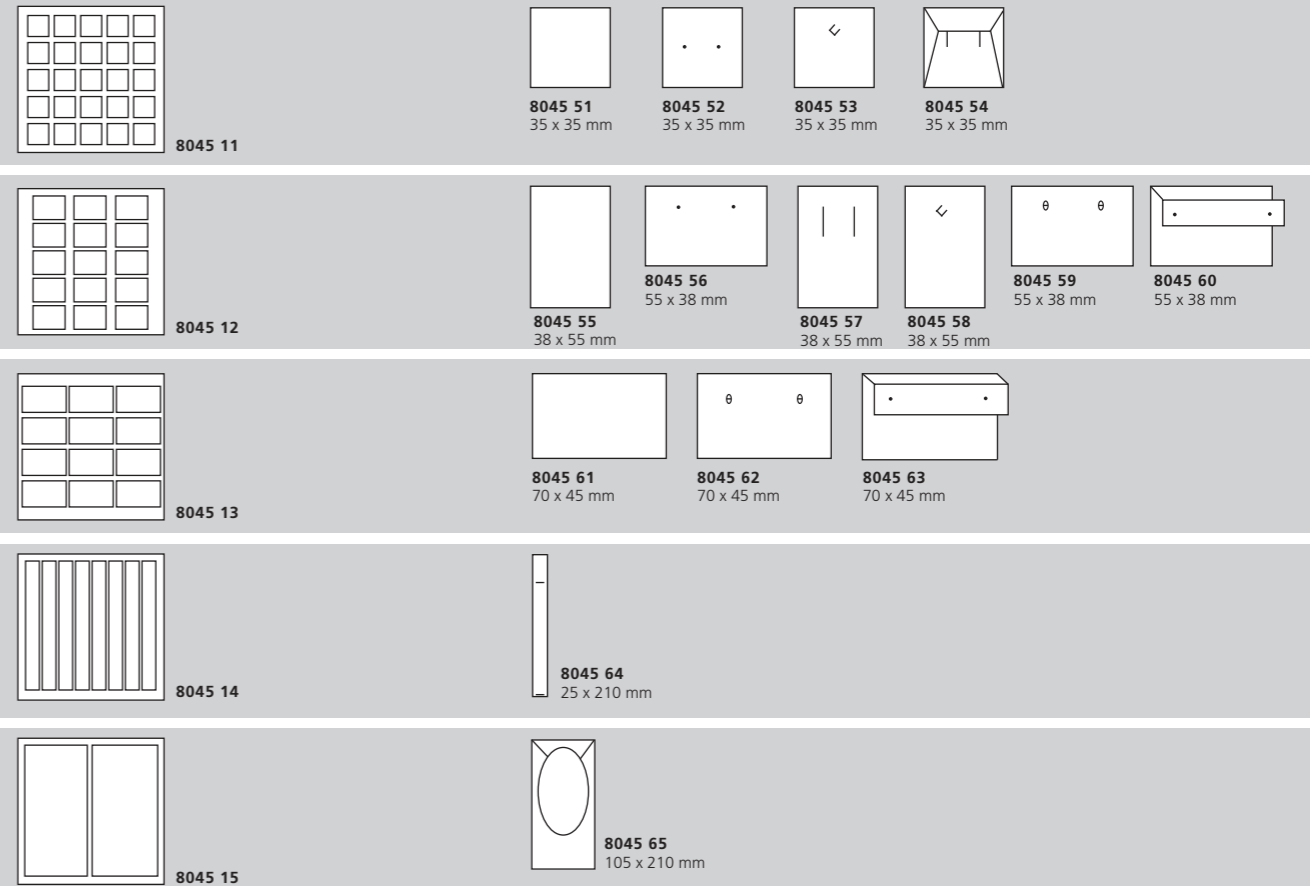

**8045 11**  
35 x 35 mm

**8045 51**  
35 x 35 mm

**8045 52**  
35 x 35 mm

**8045 53**  
35 x 35 mm

**8045 54**  
35 x 35 mm

**8045 12**

**8045 55**  
38 x 55 mm

**8045 56**  
55 x 38 mm

**8045 57**  
38 x 55 mm

**8045 58**  
38 x 55 mm

**8045 59**  
55 x 38 mm

**8045 60**  
55 x 38 mm

**8045 13**

**8045 61**  
70 x 45 mm

**8045 62**  
70 x 45 mm

**8045 63**  
70 x 45 mm

**8045 14**

**8045 64**  
25 x 210 mm

**8045 15**

**8045 65**  
105 x 210 mm

## Einlage\* insert | intérieur | interior

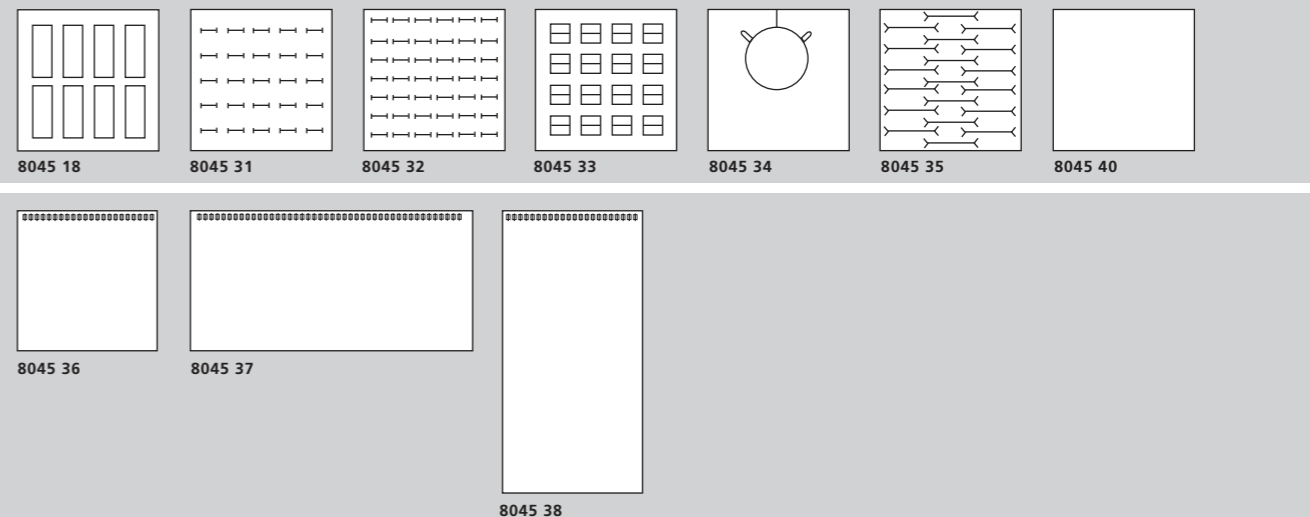

**8045 18**

**8045 31**

**8045 32**

**8045 33**

**8045 34**

**8045 35**

**8045 40**

**8045 36**

**8045 37**

**8045 38**

# SERIE 8900–8903 VARIANT

Fragen Sie nach unserer Farbkarte.  
Please ask for our special colour chart.



ECO  
Schaumstoffeinlage  
Foam pads  
Intérieur mousse  
Interior espuma

## Variant-Programm: Die Schubladen-Elemente | The drawer systems

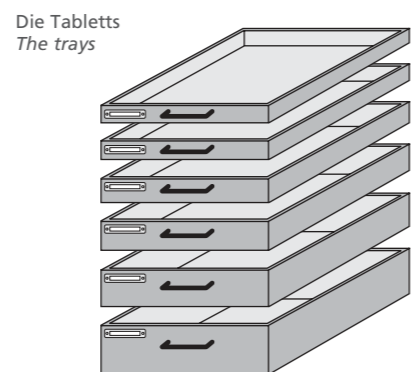
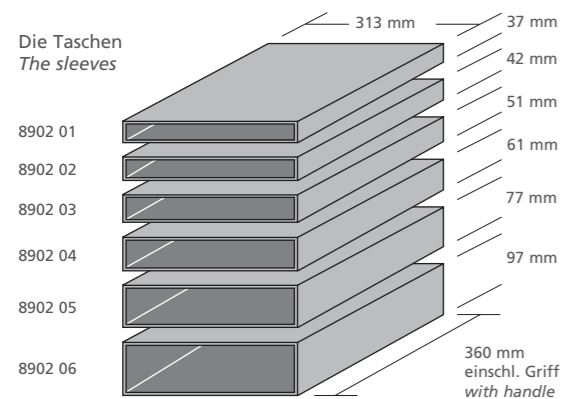

## Einrichtungs-Varianten | Furnishing variants

<b>8900 01, 37 mm</b> Universal flach, mit 3 losen Trennwänden tray universal, flat, with 3 loose dividers	<b>8900 03, 51 mm</b> <b>8900 04, 61 mm</b> Universal leer tray universal, empty	<b>8900 05, 37 mm</b> Universal flach mit Plexinut-leisten, 3 losen Trennstäben tray universal, flat, with acrylic stripes and 3 loose dividers	<b>8900 07, 37 mm</b> 7 HAU lang, Universalfächer tray with 7 compartments for gent's watch long	<b>8900 09, 42 mm</b> 14 HAU kurz, Universalfächer tray with 14 compartments for gent's watch short	<b>8900 10, 37 mm</b> 15 DAU, Universalfächer tray with 15 compartments for ladies' watch	<b>8900 12, 77 mm</b> 15 DAU mit Spange tray for 15 ladies watches, with watchsprings
<b>8900 02, 51 mm</b> Universal hoch, mit 3 losen Trennstäben tray universal, high, with 3 loose dividers	<b>8900 14, 77 mm</b> 12 HAU mit Spange tray for 12 gent's watches, with watchsprings	<b>8900 17, 97 mm</b> 48 Armreife, Plexinutleisten mit 48 losen Trennstäben tray for 48 bangles, with acrylic stripes and 48 loose dividers	<b>8900 20, 37 mm</b> 20 Taschenuhren, Universalfächer tray for 20 pocket watches, universal compartments	<b>8900 21, 37 mm</b> 36 Münzen, Universalfächer tray for 36 coins, universal compartments	<b>8900 22, 37 mm</b> 72 Anhänger, Universalfächer tray for 72 pendants, universal compartments	<b>8900 25, 51 mm</b> 78 Ringe versetzt tray for 78 rings, shifted
<b>8900 27, 61 mm</b> 48 Ringe mit Büschung, 2 lose Tablett's à 24 Ringe tray for 48 rings in cushions, 2 loose inserts for 24 rings each	<b>8900 28, 61 mm</b> 48 Ringe mit Büschung, 4 lose Tablett's à 12 Ringe tray for 48 rings in cushions, 4 loose inserts for 12 rings each	<b>8900 29, 61 mm</b> 30 Ringe mit Büschung, 2 lose Tablett's à 15 Ringe tray for 30 rings in cushions, 2 loose inserts for 15 rings each	<b>8900 30, 61 mm</b> 24 Ringe mit Büschung, 4 lose Tablett's à 6 Ringe tray for 24 rings in cushions, 4 loose inserts for 6 rings each	<b>8900 31, 37 mm</b> 56 Kartuschenfächer (35x35), Universalfächer tiefgezogen tray with 56 universal compartments (vacuum formed)	<b>8900 32, 37 mm</b> 36 Kartuschenfächer (38x50), Universalfächer tiefgezogen tray with 36 universal compartments (vacuum formed)	<b>8900 33, 37 mm</b> 30 Kartuschenfächer (38x55), Universalfächer tiefgezogen tray with 30 universal compartments (vacuum formed)
<b>8900 34, 37 mm</b> 18 Kartuschenfächer (75x50), Universalfächer tiefgezogen tray with 18 universal compartments (vacuum formed)	<b>8900 35, 51 mm</b> 48 Trauringe mit Polster, 2 lose Tablett's à 24 Paar Trauringe tray for 48 wedding rings in cushions, 2 loose inserts for 24 pairs of wedding rings	<b>8900 37, 42 mm</b> 25 Universalkartuschen, Universalfächer tray with 25 universal compart., 25 universal pads included	<b>8900 38, 42 mm</b> 25 Collier-Anhängerkartuschen, Universalfächer tray with 25 universal compart., 25 pads for necklace pend. included	<b>8900 39, 51 mm</b> 36 Ohrringkartuschen, Universalfächer tray with 36 universal compart., 36 pads for earrings included	<b>8900 41, 51 mm</b> 22 Perlketten, mit Tasche und Klappe tray for 22 pearl necklaces, with pocket and lateral flaps	<b>8900 42, 51 mm</b> 10 Colliers, gebogene Fächer mit Tasche und Klappe tray for necklaces in curved compartments with pocket and flap
<b>8900 43, 97 mm</b> 16 Colliers, 4 Platten übereinander à 4 Colliers tray for 16 necklaces with 4 inserts for 4 necklaces each to be stacked	<b>8900 44, 42 mm</b> 4 Colliers, 4 Platten à 1 Collier tray for 4 necklaces with 4 inlets for 1 necklace each	<b>8900 45, 37 mm</b> 24 Collierkettchen quer, Hakenleiste mit Tasche tray for 24 chains, transversal row of hooks and opposite pocket	<b>8900 47, 97 mm</b> 500 Collierkettchen in 11 Fächern quer, Hakenleiste an Balken tray for 500 chains in 11 transv. pockets, row of hooks on bars	<b>8900 49, 77 mm</b> 144 Tierkreiszeichen-kartuschen, 12 lose Tablett's à 12 Fächer tray with 144 pads f. charms, in 12 loose inserts stackable with 12 univ. compar. each	<b>8900 78, 51 mm</b> 78 Ringe versetzt, ECO Schaum gestanz drawer for 78 rings, shifted, ECO foam, with cuts	<b>8900 79, 77 mm</b> 12 HAU breit, ECO Schaum gestanz drawer for 12 gent's watches, ECO foam, with cuts
<b>8900 46, 37 mm</b> 28 Collierkettchen längs, Hakenleiste ohne Tasche tray for 28 chains, lengthwise row of hooks, no opposite pocket	<b>8900 48, 42 mm</b> 25 Universalkartuschen, Universalfächer tray with 25 universal compart., 25 universal pads included	<b>8900 49, 77 mm</b> 144 Tierkreiszeichen-kartuschen, 12 lose Tablett's à 12 Fächer tray with 144 pads f. charms, in 12 loose inserts stackable with 12 univ. compar. each	<b>8900 78, 51 mm</b> 78 Ringe versetzt, ECO Schaum gestanz drawer for 78 rings, shifted, ECO foam, with cuts	<b>8900 79, 77 mm</b> 12 HAU breit, ECO Schaum gestanz drawer for 12 gent's watches, ECO foam, with cuts		

# SERIE 8910-12 COMBI-NORM

MADE IN GERMANY



Fragen Sie nach unserer Farbkarte.  
Please ask for our special colour chart.



## Combi-Norm-System: Maße und Kombinationen | Combi-Norm-System: Measurements and Combinations

Warenblock (individuell kombinierbar)  
Combi-Norm-Block (to be combined individually)

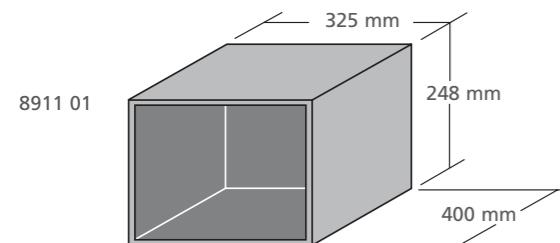

Die Schubladen  
The drawers

Die Gesamthöhe der Schubladen muss immer 224 mm ergeben.

The Norm block is only complete when the addition exactly sums up to 224 mm.

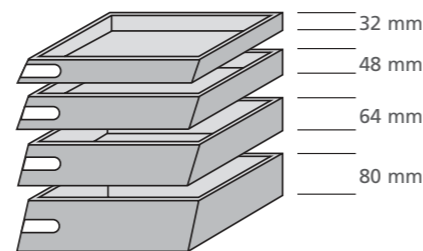

## Einrichtungs-Varianten | Furnishing variants

<b>8910 10, 32 mm</b> <b>8910 11, 48 mm</b> <b>8910 12, 64 mm</b> <b>8910 13, 80 mm</b> Universal drawer universal	<b>8912 20</b> Tablett à 36 Ringe mit Ringwulst inlay for 36 rings in puff cushions	<b>8912 21</b> Tablett à 24 Ringe mit Büschung inlay for 24 rings in cushions	<b>8912 22</b> Tablett à 8 Ringe mit Rhombusbüschung inlay for 8 rings in rhombus cushions	<b>8912 25</b> Tablett à 14 Ringe mit Rhombusbüschung inlay for 14 rings in rhombus cushions	<b>8910 31, 32 mm</b> 16 DAU, Universalfächer drawer for 16 ladies watches in universal compartments	<b>8910 32, 32 mm</b> 21 DAU, Universalfächer drawer for 21 ladies watches in universal compartments	<b>8910 33, 48 mm</b> 16 HAU kurz, Universalfächer drawer for 16 gent's watches short in universal compartments								
								<b>8910 34, 32 mm</b> 8 HAU lang, Universalfächer drawer for 8 gent's watches long in universal compartments	<b>8910 36, 80 mm</b> 15 DAU mit Spange drawer for 15 ladies watches on loose springs	<b>8910 37, 80 mm</b> 12 HAU mit Spange drawer for 12 gent's watches on loose springs	<b>8910 40, 32 mm</b> 12 Kartuschenfächer (90x85), Universalfächer drawer with 12 compartments	<b>8910 41, 32 mm</b> 18 Kartuschenfächer (75x50), Universalfächer drawer with 18 compartments	<b>8910 42, 32 mm</b> 20 Kartuschenfächer (65x65), Universalfächer drawer with 20 compartments	<b>8910 43, 32 mm</b> 20 Kartuschenfächer (50x75), Universalfächer drawer with 20 compartments	<b>8910 44, 32 mm</b> 20 Kartuschenfächer (50x83), Universalfächer drawer with 20 compartments
								<b>8910 45, 32 mm</b> 30 Kartuschenfächer (40x60), Universalfächer drawer with 30 compartments	<b>8910 50, 32 mm</b> 32 Kartuschenfächer (55x38), Universalfächer drawer with 32 compartments	<b>8910 51, 32 mm</b> 36 Kartuschenfächer (38x50), Universalfächer drawer with 36 compartments	<b>8910 52, 32 mm</b> 36 Kartuschenfächer (38x55), Universalfächer drawer with 36 compartments	<b>8910 53, 32 mm</b> 40 Kartuschenfächer (50x38), Universalfächer drawer with 40 compartments	<b>8910 54, 48 mm</b> 45 Kartuschenfächer (45x35), Universalfächer drawer with 45 compartments	<b>8910 55, 32 mm</b> 49 Kartuschenfächer (35x45), Universalfächer drawer with 49 compartments	<b>8910 56, 32 mm</b> 63 Kartuschenfächer (35x35), Universalfächer drawer with 63 compartments
								<b>8910 62, 32 mm</b> 24 Collierketten quer, Hakenleiste ohne Tasche drawer for 24 chains on row of hooks transversal, without pocket	<b>8910 64, 32 mm</b> 4 Colliers, 4 Platten à 1 Collier drawer for 4 necklaces on 4 removable pads	<b>8910 65, 32 mm</b> 30 Collierketten längs, Hakenleiste, ohne Tasche drawer for 30 chains on lengthwise row of hooks, without pocket	<b>8910 66, 48 mm</b> 14 Halsketten, Bogenfächer drawer with 14 curved compartments for necklaces	<b>8910 67, 48 mm</b> 17 Perlketten, Universalfächer drawer for 17 pearl necklaces	<b>8910 68, 37 mm</b> 56 Kartuschenfächer (35x35), Universalfächer tiefgezogen tray with 56 universal compartments (vacuum formed)	<b>8910 78, 48 mm</b> 78 Ringe versetzt, ECO Schaum gestanzte drawer for 78 rings, shifted, ECO foam, with cuts	<b>8910 79, 80 mm</b> 12 HAU breit, ECO Schaum gestanzte drawer for 12 gent's, watches, ECO foam, with cuts

Passende Kartuschen siehe Preisliste Serie 8090 | For suitable pads see series 8090 in price list